



MASTER LEDspot LV AR111

MASTER LEDspotLV AR111 D 10-50W WW 24D

Delivering a warm, halogen-like accent beam, MASTER LEDspot LV AR111 is an ideal retrofit solution for spot and general lighting applications in the hospitality and retail industry. It is particularly suitable for general lighting where the light is on all the time, such as creative accent lighting applications in shops, restaurants, hotels, and especially for galleries, exhibitions and museums. The robustly designed MASTER LEDspot LV AR111 offers various beam angles for a clearly defined beam spread. There is no UV or IR in the beam, making it suitable for illuminating heat-sensitive objects (food, organic materials, paintings, etc.). The patented intelligent driver enables broad compatibility with existing electromagnetic and electronic halogen transformers. MASTER LEDspot LV AR111 delivers huge energy savings and minimizes maintenance cost without any reduction in brightness.

Product data

• General Characteristics

Cap-Base	G53
Bulb	AR111
Rated Lifetime (hours)	45000 hr

• Light Technical Characteristics

Color Code	WW
Color Designation (text)	Warm White
Beam Angle	24 D
Beam Description	- [-]
Correlated Color Temperature	2700 K
Luminous Flux	600 Lm
Luminous Intensity	3360 cd
Color rendering index	80
Color Temperature	2700 K [CCT 2700K]
Rated Luminous Flux	600 Lm

• Electrical Characteristics

Wattage	10 W
Wattage Technical	10.0 W
Voltage	12 V
Line Frequency	50-60 Hz
Power Factor	0.85 -
Lamp Current mA	1100 mA
Dimmable	Yes

Wattage Equivalent	50 W
Starting Time	1.5 (max) s

• Measuring Conditions

Switching cycle	50000x
-----------------	--------

• Product Dimensions

Diameter D	111 mm
Overall Length C	56 mm

• Product Data

Order code	929000221902
Full product code	929000221902
Full product name	MASTER LEDspotLV AR111 D 10-50W WW 24D
Order product name	MAS LEDspotLV AR111 D 10-50W WW 24D
Pieces per pack	1
Packing configuration	6
Packs per outerbox	6
Bar code on pack - EAN1	8718291192046
Bar code on outerbox - EAN3	8718291192053
Logistic code(s) - 12NC	929000221902
Net weight per piece	0.114 kg



PHILIPS

sense and simplicity

Dimensional drawing

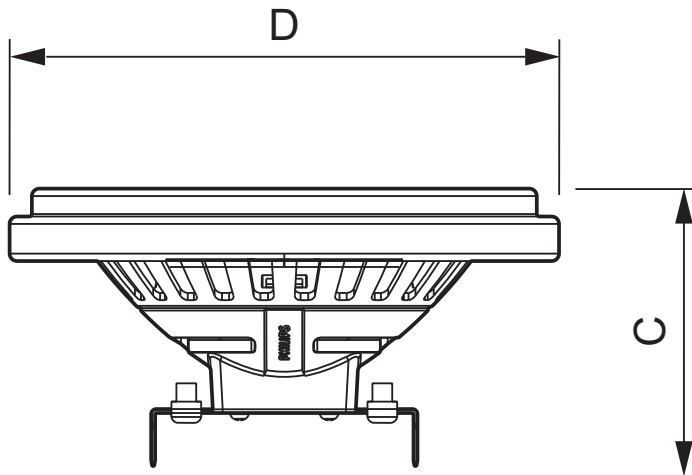

10-50W, 15-75W AR111

Product	C (Norm)	C1 (Max)	D (Norm)	D1 (Norm)
LED D 10-50W WW AR111 24D	56	-	111	-

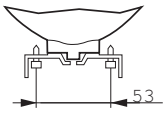

G53



© 2012 Koninklijke Philips Electronics N.V.
All rights reserved.

Specifications are subject to change without notice. Trademarks are the property of Koninklijke Philips Electronics N.V. or their respective owners.

www.philips.com/lighting

2012, August 4
data subject to change